

## TRANSISTOR COVER

- ┆ MATERIAL:P.B.T
- ┆ FLAME CLASS :94V-0
- ┆ COLOR:NATURAL
- ┆ UNIT:mm

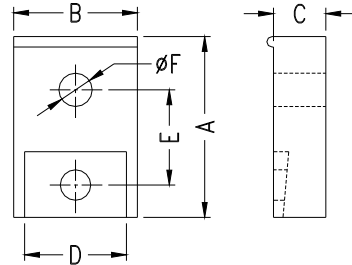

TC-1/TC-1A/TC-1C/TC-2

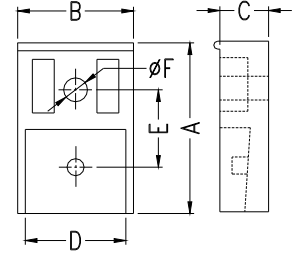

TC-3

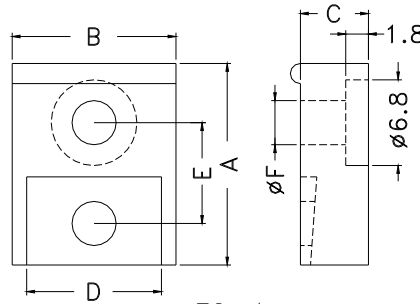

TC-4

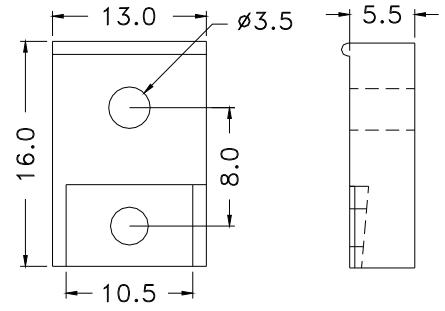

TC-5A

PART NO	A	B	C	D	E	F	PACKAGE
YPTCC-1	16.0	13.0	5.4	10.7	8.0	3.5	YPTOC-220
YPTCC-1A	19.3	13.0	5.4	10.7	10.0	3.6	YPTOC-220
YPTCC-1C	17.8	13.0	5.5	10.7	9.3	3.5	YPTOC-220
YPTCC-2	19.0	18.0	6.0	16.4	10.5	3.5	YPTOC-218
YPTCC-3	28.0	19.0	8.0	16.5	12.8	3.9	YPTOC-3P
YPTCC-4	16.0	13.0	5.4	10.7	8.0	3.5	YPTOC-220

## TRANSISTOR COVER

- ┆ BODY MATERIAL:NYLON 66 UL94V-2
- ┆ CLIP MATERIAL:STAINLESS-430
- ┆ COLOR:BLACK
- ┆ UNIT:mm

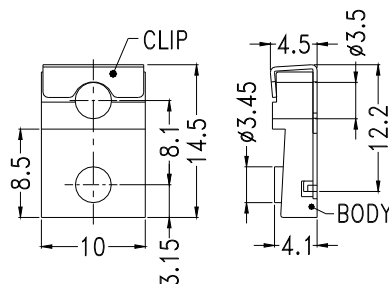

PART NO	PACKAGE
YPTCCSE-1	1000

## TRANSISTOR WASHERS

MATERIAL:P.B.T V-0 or N66 V-2  
 AVAILABLE  
 MATERIAL:N 66 V-2 AVAILABLE  
 ONLY  
 OTHR ITEMS=MATERIAL:P.B.T, N46,PPS,  
 N66V-0,N66V-2 AVAILABLE  
 COLOR:NATURAL  
 UNIT:mm

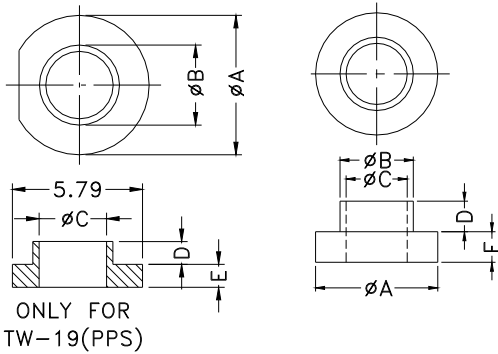

PART NO	A	B	C	D	E		PACKAGE
YPTWC-1	6.0	3.6	3.0	1.5	1.5	YPTOC-220	2000
YPTWC-2	6.2	3.5	3.0	3.0	1.5		
YPTWC-3	6.2	3.5	3.0	2.5	2.0		
YPTWC-4	6.0	3.5	3.0	2.0	2.0		
YPTWC-5	6.2	3.5	2.9	1.2	1.0		
YPTWC-6	6.2	3.5	2.9	1.4	1.2		
YPTWC-7	8.0	3.8	3.1	2.8	1.2	YPTOC-3	
YPTWC-8	8.0	3.8	3.1	1.2	1.2		
YPTWC-9	10.0	6.0	5.0	5.0	1.0	WASHERS	1000
YPTWC-10	10.0	5.0	4.0	4.0	1.0		
YPTWC-11	9.5	6.3	4.5	1.2	1.2		
YPTWC-12	9.5	6.3	4.1	0.8	1.7		
YPTWC-14	9.9	8.3	6.5	1.5	1.0	YPTOC-220	
YPTWC-15	6.2	3.6	3.0	2.4	1.9		
YPTWC-16	6.1	3.5	2.9	1.6	1.4		
YPTWC-17	6.1	3.55	3.0	1.5	2.0	WASHERS	2000
YPTWC-18	6.35	5.15	3.5	1.6	0.6		
YPTWC-19	6.22	3.56	3.02	1.02	1.02		
YPTWC-20	6.5	3.5	2.95	4.0	0.9		
YPTWC-21	7.0	5.0	3.0	5.8	2.0		
YPTWC-22	11.9	7.9	4.0	3.0	2.6		
YPTWC-23	7.1	5.0	3.0	2.3	2.0		
YPTWC-24	6.35	3.5	3.0	2.0	1.2		
YPTWC-25	7.93	4.83	3.05	1.15	1.15		
YPTWC-26	6.0	3.7	3.0	5.2	1.0		
YPTWC-27	6.0	3.55	2.95	1.4	1.4		
YPTWC-29	14.0	7.5	6.0	1.8	1.2		
YPTWC-30	14.0	9.8	6.6	1.7	0.9		
YPTWC-31	16.0	11.4	10.0	0.8	0.7		
YPTWC-33	6.0	3.5	2.5	2.3	5.0		
YPTWC-34	6.0	3.5	2.5	11.0	5.0		
YPTWC-35	6.0	3.55	2.95	1.2	1.3		
YPTWC-36	15.7	9.7	4.5	6.5	5.0		
YPTWC-37	6.0	3.55	2.95	3.2	2.0		
YPTWC-38	6.1	3.5	2.95	1.5	1.1		

## TRANSISTOR WASHERS

┆ MATERIAL:P.B.T(UL)  
 ┆ FLAME CLASS :94V-0  
 ┆ COLOR:NATURAL  
 ┆ UNIT:mm

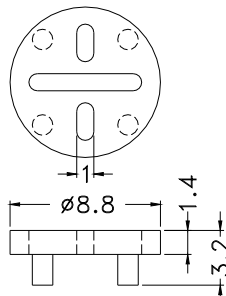

PART NO	PACKAGE
YPTOC-05	1000

## TRANSISTOR WASHERS

- ┆ MATERIAL: NYLON 66(UL)
- ┆ FLAME CLASS :94V-2
- ┆ COLOR:NATURAL
- ┆ UNIT:mm

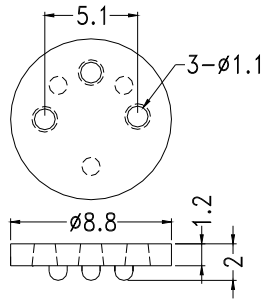

PART NO	PACKAGE
YPTOC-05S	2000

## TRANSISTOR WASHERS

- ┆ MATERIAL: NYLON 66(UL)
- ┆ FLAME CLASS :94V-2
- ┆ COLOR:NATURAL
- ┆ UNIT:mm

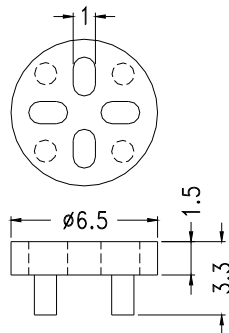

PART NO	PACKAGE
YPTOC-18	1000

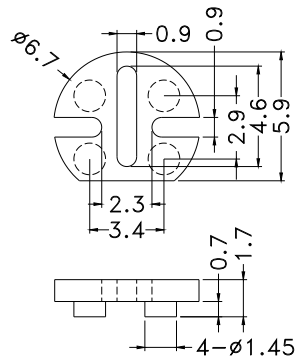

PART NO	PACKAGE
YPTOC-18S	1000

## TRANSISTOR WASHERS

- ┆ MATERIAL: NYLON 66(UL)
- ┆ FLAME CLASS :94V-2
- ┆ COLOR:NATURAL
- ┆ UNIT:mm

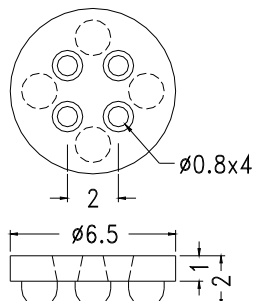
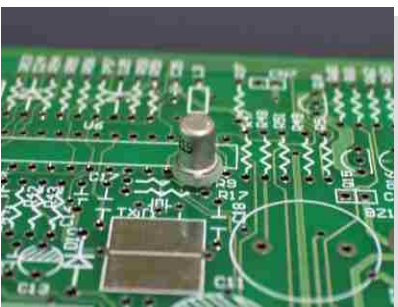

PART NO	PACKAGE
YPTOC-18M	2000

## TRANSISTOR WASHERS

- ┆ MATERIAL:NYLON 66(UL)
- ┆ FLAME CLASS :94V-2
- ┆ COLOR:NATURAL
- ┆ UNIT:mm

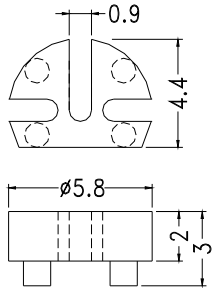

PART NO	PACKAGE
YPTOC-92	2000

## PARTS WASHER

- ┆ MATERIAL:NYLON 66(UL)
- ┆ FLAME CLASS :94V-2
- ┆ COLOR:NATURAL
- ┆ UNIT:mm

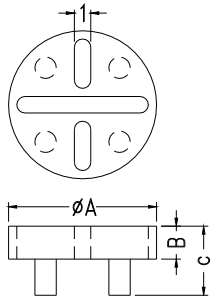

PART NO	A	B	C	PACKAGE
YPBWC-1	9.0	2.0	4.2	2000
YPBWC-2	14.0	1.0	2.1	

## TRANSISTOR WASHERS

- ┆ MATERIAL:NYLON 66(UL)
- ┆ FLAME CLASS :94V-2
- ┆ COLOR:NATURAL
- ┆ UNIT:mm

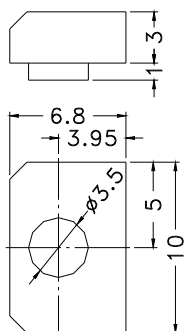
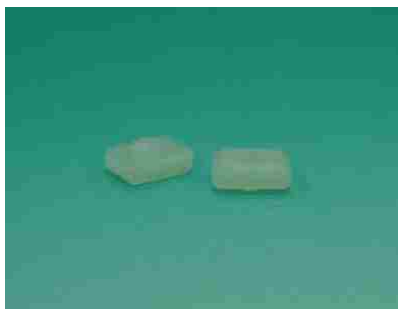

PART NO	PACKAGE
YPTRCF-1	2000

## TRANSISTOR WASHERS

- ┆ MATERIAL:PBT(UL)
- ┆ FLAME CLASS :94V-0
- ┆ COLOR:NATURAL
- ┆ UNIT:mm

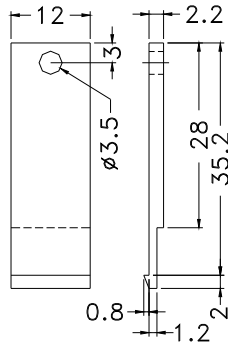
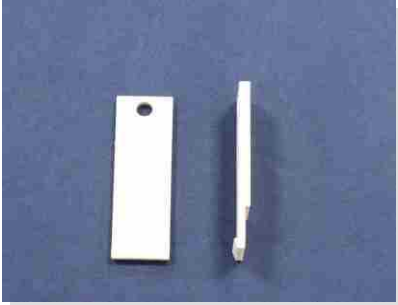

PART NO	PACKAGE
YPTCCP-1	1000

## TRANSISTOR HOUSING

- ┆ MATERIAL:NYLON 66(UL)
- ┆ FLAME CLASS :94V-2
- ┆ COLOR:BLACK
- ┆ UNIT:mm

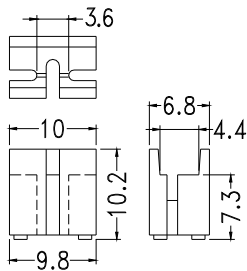
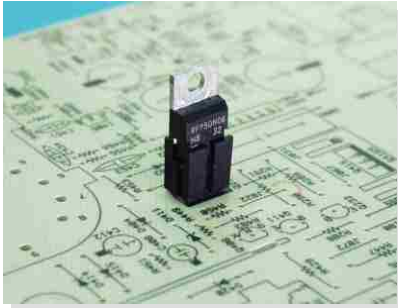

PART NO	PACKAGE
YPTRC-1	1000

## TRANSISTOR HOUSING

- ┆ MATERIAL:NYLON 66(UL)
- ┆ FLAME CLASS :94V-2/94V-0
- ┆ COLOR:BLACK
- ┆ UNIT:mm

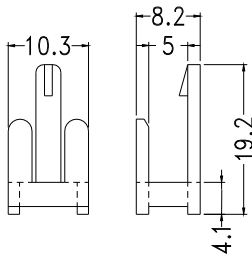
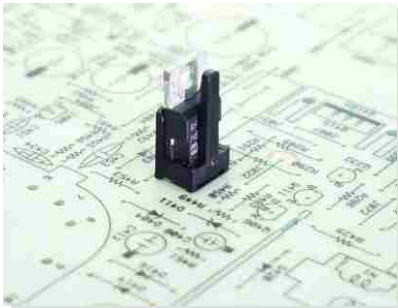

PART NO	PACKAGE
YPTRC-2	1000

## TRANSISTOR HOUSING

- ┆ MATERIAL:NYLON 66(UL)
- ┆ FLAME CLASS :94V-2
- ┆ COLOR:NATURAL/BLACK
- ┆ UNIT:mm

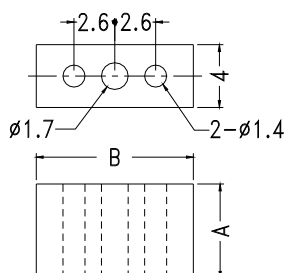

PART NO.	A	B	PACKAGE
YPTRC3-3S	3.0	9.8	1000
YPTRC3-3	3.7	9.8	
YPTRC3-4	4.0	9.8	
YPTRC3-3	6.0	9.8	
YPTRC3-5	5.0	10.0	
YPTRC3-7	7.0	9.8	

## TRANSISTOR HOUSING

- ┆ MATERIAL: NYLON 66(UL)
- ┆ FLAME CLASS :94V-2
- ┆ COLOR:NATURAL
- ┆ UNIT:□

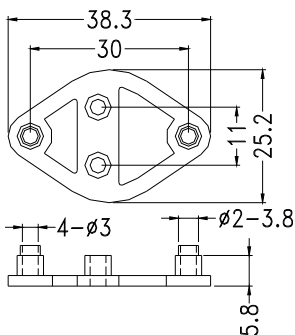

PART NO	PACKAGE
YPTRC-4	500

## TRANSISTOR HOUSING

- ┆ MATERIAL: NYLON 66(UL)
- ┆ FLAME CLASS :94V-2
- ┆ COLOR:BLACK
- ┆ UNIT:mm

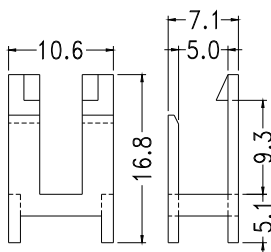
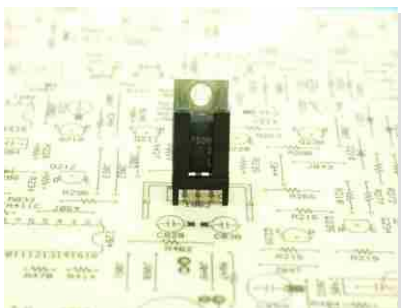

PART NO	PACKAGE
YPTRC-5	1000

## TRANSISTOR HOUSING

- ┆ MATERIAL: NYLON 66(UL)
- ┆ FLAME CLASS :94V-0
- ┆ COLOR:NATURAL
- ┆ UNIT:mm

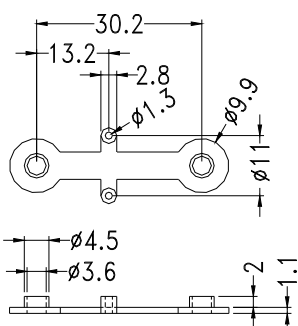

PART NO	PACKAGE
YPTRC-6	1000

## TRANSISTOR HOUSING

- ┆ MATERIAL:P.B.T(UL)
- ┆ FLAME CLASS :94V-0
- ┆ COLOR:NATURAL
- ┆ UNIT:mm

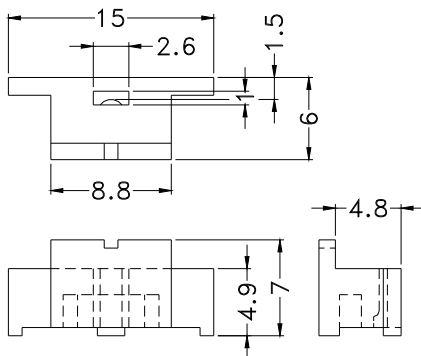

PART NO	PACKAGE
YPTRC-7	1000

## TRANSISTOR HOUSING

- ┆ MATERIAL:P.B.T(UL)
- ┆ FLAME CLASS :94V-0
- ┆ COLOR:BLACK
- ┆ UNIT:mm

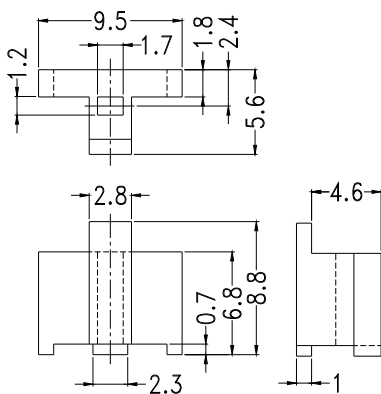

PART NO	PACKAGE
YPTRC-8	1000

## TRANSISTOR COVER

- ┆ MATERIAL:NYLON66(UL)
- ┆ FLAME CLASS:94V-2
- ┆ COLOR:NATURAL/BLACK
- ┆ UNIT:mm

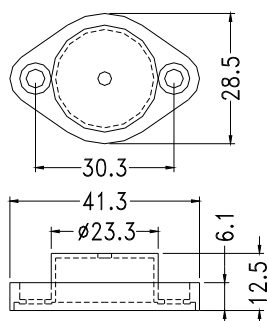

PART NO	PACKAGE
YPTRCC-1	200



## SHEET CLAMP

- ┆ MATERIAL:SUS304
- ┆ COLOR:SILIVER
- ┆ UNIT:mm

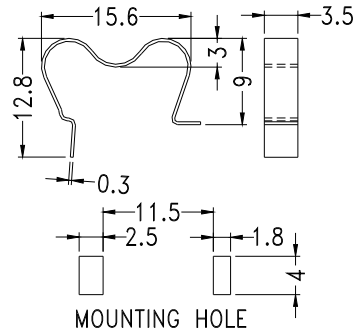

PART NO	PACKAGE
YPTOC-220ST	1000

## TRANSISTOR HOUSING

- ┆ MATERIAL:NYLON 66(UL)
- ┆ FLAME CLASS :94V-2
- ┆ COLOR:NATURAL
- ┆ UNIT:mm

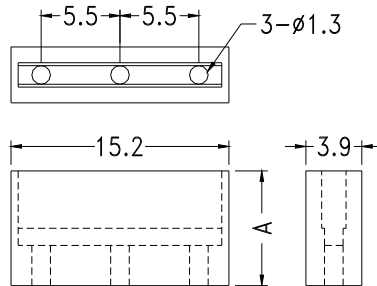

PART NO	A	PACKAGE
YPTRCW-8	8.0	1000
YPTRCW-10	10.0	

## HALL SENSOR HOUSING

- ┆ MATERIAL:NYLON 66 (UL)
- ┆ FLAME CLASS :94V-2
- ┆ COLOR:WHITE
- ┆ UNIT:mm

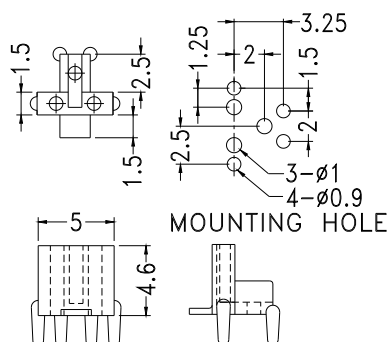
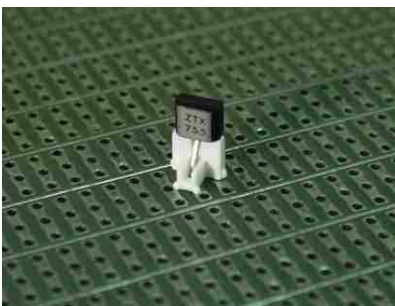

PART NO	PACKAGE
YPHLC5-1	2000