

Test Pins

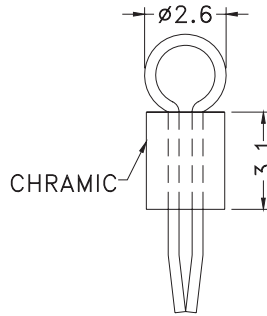

PART NO	PACKAGE
YPTECST-7CN	1000

- MATERIAL: PHOSPHOR BRONZE
- FINISH: GOLD PLATED
- UNIT: mm

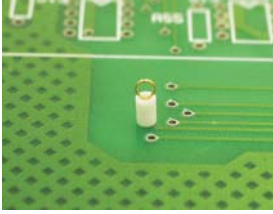
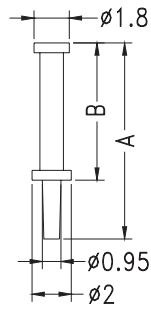
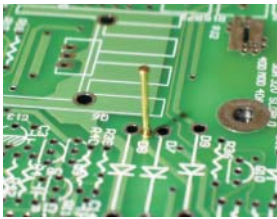

PART NO	A	B	PACKAGE
YPTECST-4	14.0	11.0	1000
YPTECST-5	10.0	7.0	2000

- MATERIAL: GOLD PLATED COPPER
- UNIT: mm

HOLE IN P.C.B $\varnothing 0.95$

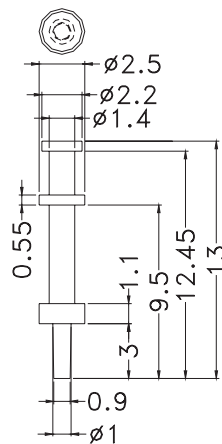

PART NO	PACKAGE
YPTECST-8	2000

- MATERIAL: GOLD PLATED COPPER
- UNIT: mm

HOLE IN P.C.B $\varnothing 1.0$

Test Pins

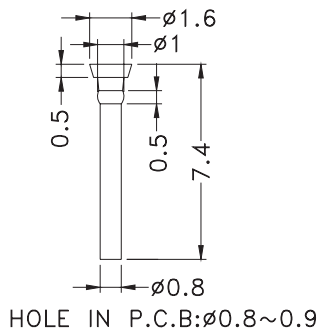

PART NO	PACKAGE
YPTECST-10	2000

- MATERIAL: TIN PLATED COPPER
- UNIT: □

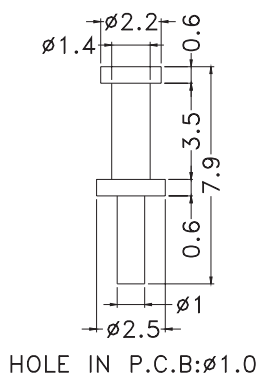
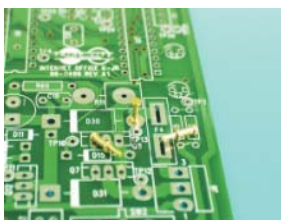

PART NO	PACKAGE
YPTECST-22	2000

- MATERIAL: BRASS
- FINISH: GOLD PLATED
- UNIT: mm

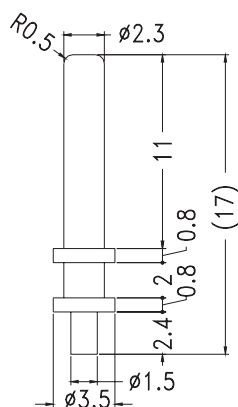
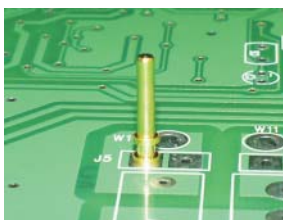

PART NO	PACKAGE
YPTECST-27	2000

- MATERIAL: COPPER
- FINISH: GOLD PLATED
- UNIT: mm